

ULA-30002

Light Linear LA 6 Surface Floodlight

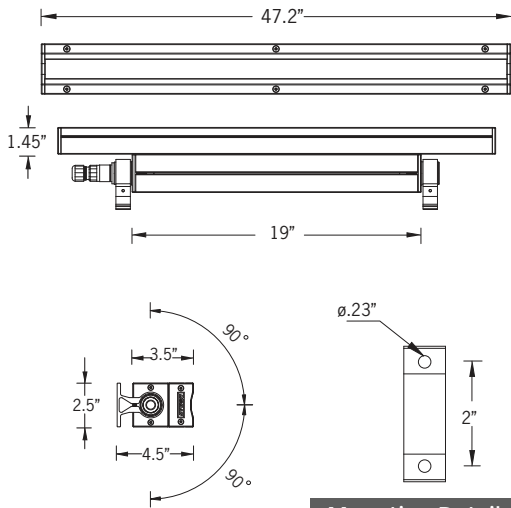

55w LED 5703 Lumens
IP65 • Suitable For Wet Locations
IK10 • Impact Resistant (Vandal Resistant)
Weight 12.5 lbs



Mounting Detail

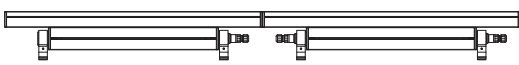

Continuous Row Mounting
(Waterproof wiring gland configuration must be specified)

Construction

Aluminum
 Less than 0.1% copper content – Marine Grade 6060 extruded & LM6 Aluminum High Pressure die casting provides excellent mechanical strength, clean detailed product lines and excellent heat dissipation.

Pre paint
 8 step decrease and phosphate process that includes deoxidizing and etching as well as a zinc and nickel phosphate process before product painting.

Memory Retentive -Silicon Gasket
 LM6 Aluminum is used for its excellent mechanical strength and thermal dissipation properties in low and high ambient temperatures. The superior thermal heat sink design by Ligman used in conjunction with the driver, controls thermals below critical temperature range to ensure maximum luminous flux output, as well as providing long LED service life and ensuring less than 10% lumen depreciation at 50,000 hours.

Thermal management
 LM6 Aluminum is used for its excellent mechanical strength and thermal dissipation properties in low and high ambient temperatures. The superior thermal heat sink design by Ligman used in conjunction with the driver, controls thermals below critical temperature range to ensure maximum luminous flux output, as well as providing long LED service life and ensuring less than 10% lumen depreciation at 50,000 hours.

Surge Suppression
 Standard 10kv surge suppressor provided with all fixtures.

BUG Rating
 B5 - U5 - G5

Finishing
 All Ligman products go through an extensive finishing process that includes fettling to improve paint adherence.

Paint
 UV Stabilized 4.9Mil thick powder coat paint and baked at 200 Deg C. This process ensures that Ligman products can withstand harsh environments. Rated for use in natatoriums.

Inspired by Nature Finishes
 The Inspired by nature Finishing is a unique system of decorative powder coating. Our metal decoration process can easily transform the appearance of metal or aluminum product into a wood grain finish.

This patented technology enables the simulation of wood grain, and even marble or granite finish through the use of decorative powder coating.

The wood grain finish is so realistic that it's almost undistinguishable from real wood, even from a close visual inspection. The system of coating permeates the entire thickness of the coat and as a result, the coating cannot be removed by normal rubbing, chipping, or scratching.

The Coating Process
 After pre-treatment the prepared parts are powder coated with a specially formulated polyurethane powder. This powder provides protection against wear, abrasion, impact and corrosion and acts as the relief base color for the finalized metal decoration.

The component is then wrapped with a sheet of non-porous film with the selected decoration pattern printed on it using special high temperature inks.

This printed film transfer is vacuum-sealed to the surface for a complete thermo print and then transferred into a customized oven. The oven transforms the ink into different forms within the paint layer before it becomes solid. Finally, the film is removed, and a vivid timber look on aluminum remains.

Wood grain coating can create beautiful wood-looking products of any sort. There are over 300 combinations of designs currently in use. Wood grains can be made with different colors, designs, etc.

Our powder coatings are certified for indoor and outdoor applications and are backed by a comprehensive warranty. These coatings rise to the highest conceivable standard of performance excellence and design innovation.

- Added Benefits**
- Resistance to salt-acid room, accelerated aging
 - Boiling water, lime and condensed water resistant
 - Anti-Graffiti, Anti-Slip, Anti-Microbial, Anti-Scratch
 - Super durable (UV resistant)
 - TGIC free (non-toxic)

Hardware
 Provided Hardware is Marine grade 316 Stainless steel.

Anti Seize Screw Holes
 Tapped holes are infused with a special anti seize compound designed to prevent seizure of threaded connections, due to electrolysis from heat, corrosive atmospheres and moisture.

Crystal Clear Low Iron Glass Lens
 Provided with tempered, impact resistant crystal clear low iron glass ensuring no green glass tinge.

Optics & LED
 Precise optic design provides exceptional light control and precise distribution of light.
 LED CRI > 80

Lumen - Maintenance Life

Efficient quality linear fixture portfolio. Coordinated grazing-floodlight range with multiple optics and component options.

Light Linear LA 6 wall wash or wall grazing floodlight family is designed as a perfect solution for color changing applications, as well as static color for architectural structures, wall grazing, column lighting and linear floodlighting. This high performance luminaire, with superior optic design is suitable for many applications including commercial, historic or modern architectural interiors and exteriors.

Two different lengths, 2' and 4' allow the luminaire installation to be tailored exactly to the architectural structure. Luminaires can be installed end to end, without any gaps or shadows in the lighting design. An integral driver is provided, however this product can be supplied with remote driver applications, please contact the factory for more details.

Light Linear LA is available in 2700K, 3000K, 3500K and 4000K, as well as RGBW. This linear line is also provided in Inground, Recessed wall and Pendant, see Ligman website

Additional Options (Consult Factory For Pricing)

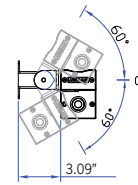

ADJ3 - 3" Extended Arm

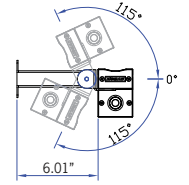

ADJ6 - 6" Extended Arm

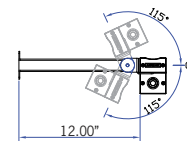

ADJ12 - 12" Extended Arm

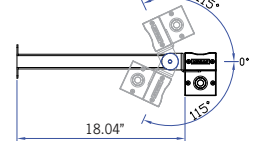

ADJ18 - 18" Extended Arm

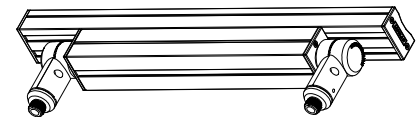

TKM - Threaded Knuckle Mount



ULA-30002

Light Linear LA 6 Surface Floodlight

PROJECT		DATE	
----------------	--	-------------	--

QUANTITY		TYPE		NOTE	
-----------------	--	-------------	--	-------------	--

ORDERING EXAMPLE || ULA - 30002 - 55w LED - N - W30 - 02 - 120/277v

ULA-30002					
LAMP	BEAM	LED COLOR	FINISH COLOR	VOLTAGE	
55w LED 5703 Lumens	VN - Very Narrow 12° N - Narrow 14° M - Medium 24° W - Wide 42° E - Elliptical 18° x 35°	W27 - 2700K W30 - 3000K W35 - 3500K W40 - 4000K	01 - BLACK RAL 9011 02 - DARK GREY RAL 7043 03 - WHITE RAL 9003 04 - METALLIC SILVER RAL 9006 05 - MATTE SILVER RAL 9006 06 - LIGMAN BRONZE 07 - CUSTOM RAL	120/277v Other - Specify	

--	--	--	--

ADDITIONAL OPTIONS

- | | |
|------------------------------|--------------------------|
| F - Frosted Lens | ADJ3 - 3" Extended Arm |
| DIM - 0-10v Dimming | ADJ6 - 6" Extended Arm |
| NAT - Natatorium Rated | ADJ12 - 12" Extended Arm |
| TKM - Threaded Knuckle Mount | ADJ18 - 18" Extended Arm |

INSPIRED BY NATURE FINISHES

SW01 - OAK FINISH		THERE IS AN ADDITIONAL COST FOR THESE FINISHES
SW02 - WALNUT FINISH		
SW03 - PINE FINISH		
DF - DOUGLAS FIR FINISH		
CW - CHERRY WOOD FINISH		
NW - NATIONAL WALNUT FINISH		
SU01 - CONCRETE FINISH		
SU02 - SOFTSCAPE FINISH		
SU03 - STONE FINISH		
SU04 - CORTEN FINISH		

More Custom Finishes Available Upon Request

Consult factory for pricing and lead times

Oak	Cherry	Beech	Carbon
Walnut	Chestnut	Bamboo	Galvanized
Pine	Mahogany	Birch	Steel



CABLE GLAND

Ligman supplies this luminaire with 3ft of cable to connect to power and where specified controls. [Additional cable lengths can be provided and should be specified]

It is important to identify what configuration is required for the installation [One Gland or Two Gland Units]
A waterproof cable connector can be provided and should be ordered as an optional extra

1GL

Specify Quantity

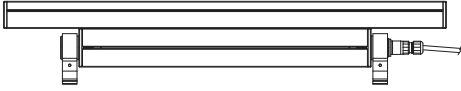

1GL - One Gland for Single Fixture and End Installation

CNCT

Specify Quantity



**Optional
CNCT - Waterproof Cable Connector**

2GL

Specify Quantity

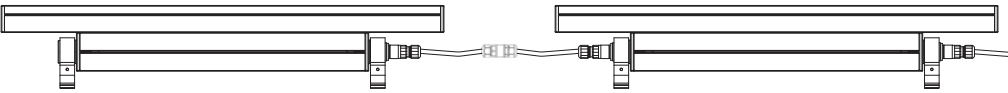

2GL - Two Gland for Continuous Row Mounting

EXTRA CABLE LENGTH

Specify Cable Length in Feet

Custom lengths can be provided
as an option [contact factory for pricing]

Light Linear LA Product Family



Light Linear LA 1

- ULA-60001-28w-2847lm
- ULA-60002-57w-5703lm
- ULA-60003-28w-2566lm [Asymmetric]
- ULA-60004-57w-5140lm [Asymmetric]



Light Linear LA 2

- ULA-60013-33w-1916lm
- ULA-60014-66w-3839lm



Light Linear LA 3

- ULA-95001-28w-2847lm
- ULA-95002-55w-5703lm



Light Linear LA 4

- ULA-95021-28w-2847lm
- ULA-95022-55w-5703lm



Light Linear LA 6

- ULA-30001-28w-2847lm
- ULA-30002-55w-5703lm



Light Linear LA 7

- ULA-30013-33w-2018lm
- ULA-30014-66w-4043lm



Light Linear LA 8

- ULA-30021-28w-2847lm
- ULA-30022-55w-5703lm



Light Linear LA 9

- ULA-40001-28w-2847lm
- ULA-40002-57w-5703lm



Light Linear LA 10

- ULA-40013-33w-3948lm
- ULA-40014-66w-4043lm